

amequipment.com
 Phone: (541) 327-1546
 FAX: (541) 327-1548

218 series motor

- 218-1001**
- 18Nm stall torque actuator motor, LH
 - 12V reversible (24V available upon request)
 - Water resistant
 - For use with gears, sprockets, and drives
 - Weighs 2.6 pounds

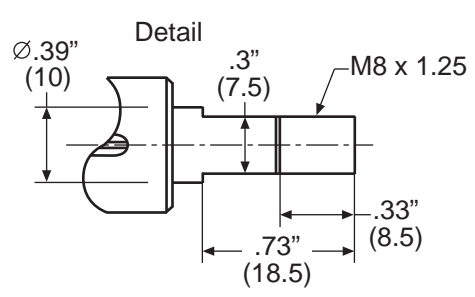
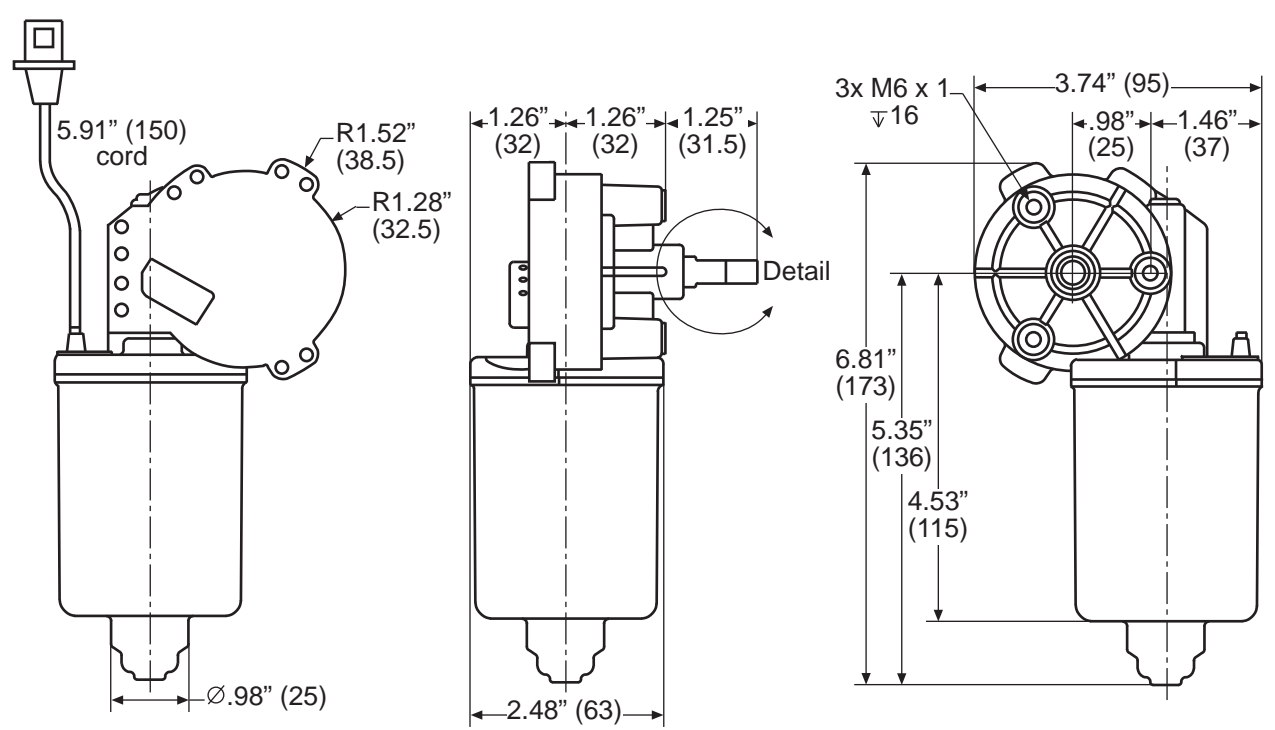
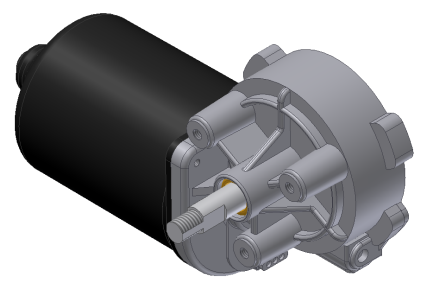

Mounting bolt: 414-1131
 Mate nut: 414-1132

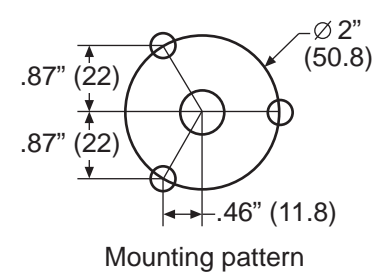

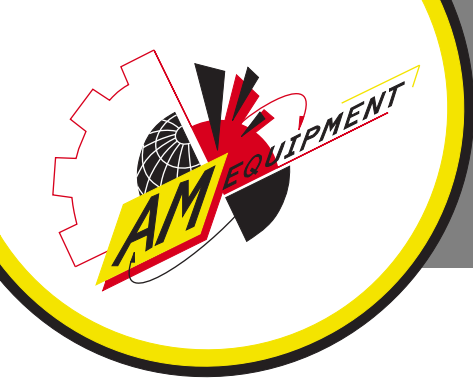

amequipment.com
 Phone: (541) 327-1546
 FAX: (541) 327-1548

218 series motor

218-1001

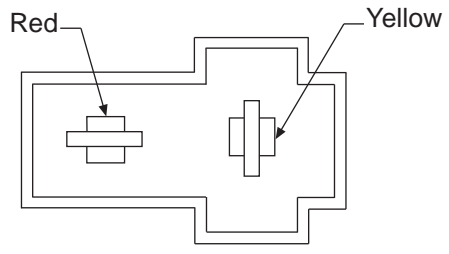

Terminal housing: 317-1057
 Terminal: 317-1054
 Mate terminal housing: 317-1056
 Mate terminal: 317-1055

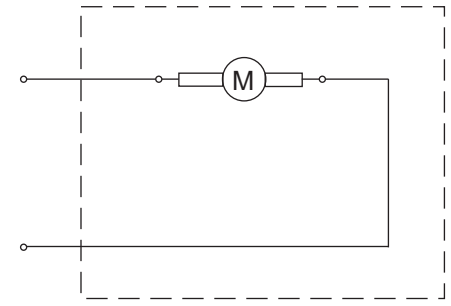

Red (+), yellow (-) = CW
 Yellow (+), red (-) = CCW (preferred rotation)

Clockwise Motor Shaft Rotation		
Data Point	Data Type	Value Range
No Load	Current (A)	1.7 - 1.4
	Speed (rpm)	116.2 - 95.1
Stall Load	Torque (Nm)	21.3 - 17.5
	Current (A)	36.0 - 29.4
Peak Power	Power (W)	60.0 - 49.1
	Torque (Nm)	11.1 - 9.1
Nominal (Peak Efficiency)	Power (W)	36.5 nominal
	Speed (rpm)	82.1 nominal
	Current (A)	7.0 nominal
	Torque (Nm)	4.3 nominal
Counter-Clockwise Motor Shaft Rotation		
Data Point	Data Type	Value Range
No Load	Current (A)	1.6 - 1.3
	Speed (rpm)	113.5 - 92.9
Stall Load	Torque (Nm)	20.6 - 16.9
	Current (A)	35.7 - 29.2
Peak Power	Power (W)	55.5 - 45.4
	Torque (Nm)	10.5 - 8.6
Nominal (Peak Efficiency)	Power (W)	34.3 nominal
	Speed (rpm)	79.6 nominal
	Current (A)	7.4 nominal
	Torque (Nm)	4.2 nominal

