

# Operating Manual

## ***e - STATION*** BC6HP

Microprocessor controlled high-performance rapid charger/discharger  
with integrated balancer, 250watts of charging power  
USB PC link and firmware upgrade, Temperature sensor

Charge current up to 10A, discharge current up to 7A, 1 to 6  
series of Lilo/LiPo/LiFe, 1 to 18 cells of NiCd/NiMH, 2 to 24V  
of Lead-acid (Pb)

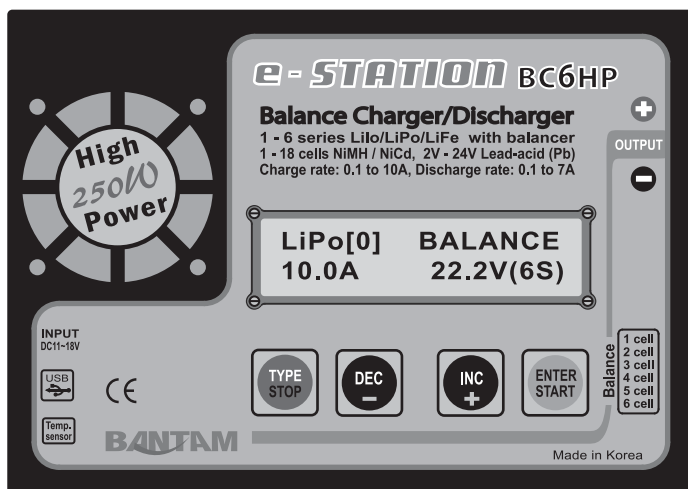

**BANTAM**

\* We reserve the right to commit modifications.  
\* Copyright reserved

Thank you for purchasing the e-STATION BC6HP charger. You get a rapid charger/discharger with integrated balancing circuit, which is computerised with a high performance microprocessor and specialised operating software. Please read this operating manual completely and attentively as it contains a wide variety of specific programming and safety information.

You need to keep this manual in a safe place, and be sure to pass it on to the new owner if you ever dispose of BC6HP.

## ● Special features

### - Operating software

Every operating program in the unit is controlled with mutual links and communications to prevent every possible error, so it introduces the maximum safety, such as input voltage warning, reverse polarity protection and Lithium cell-count input error warning. The entire firmware can be upgraded via USB from internet download at our web page, when there needs to be changed.

### - High-power and high-performance circuit

BC6HP employs the circuit that has maximum output power of 250Watts. As a result, it can charge or discharge up to 18 cells of NiCd/NiMH and 6 series of Lithium batteries with maximum current of 10A. Furthermore, the cooling system is so efficient that can hold such a power without any trouble running the circuit or the operating program.

### - Accept various types of Lithium battery

BC6HP can accept three types of Lithium batteries - Lilo, LiPo and LiFe. They have different characteristics by their chemistry. You can select any one of them that you are going to process before the job. For their specifications, refer 'Warnings and safety notes' section.

### - Lithium battery 'Fast' and 'Storage' mode

You can charge Lithium battery for special purposes. 'Fast' charge reduces the charging time of Lithium battery and 'Storage' mode controls the final voltage of the battery to be suit for long time storage.

### - Maximum safety

Delta-peak sensitivity : The automatic charge termination program works on the principle of the Delta-peak voltage detection. (NiCd/NiMH)

Auto-charge current limit : When charging NiCd or NiMH at 'AUTO' current mode, you can set the upper limit of charge current to avoid from feeding high current to the battery. This is very useful when charging the low impedance and small capacity NiMH battery in 'AUTO' mode.

Capacity limit : The charging capacity always calculated by multiple of the charging current and time. If the charging capacity exceeds the limit the process will be terminated automatically when you set the maximum value.

Temperature limit(\*) : The temperature of the battery on charging will rise by its internal chemical reaction. If you set the limit of temperature the process will be expired forcibly when the limit has been reached.

Processing time limit : You can also restrain the maximum processing time to prevent from any possible defect.

Input power monitor : To protect the car battery using as input power from being damaged, its voltage always being monitored. If it drops below the lower limit the process will be ended automatically.

**- Data store/load**

For users convenience, it can store maximum 10 data of different batteries. You can establish the data contains program setting of the battery to charge or discharge. These data can be called back at any time you need and the process can be executed without program setting.

**- PC based analysis using USB communication(\*\*)**

For technical expert, BC6HP offers PC based program can analysis the characteristic of the battery by USB port. It shows a graph of voltage, current, capacity and temperature curves. It also shows the individual voltage of each cell in the Lithium battery pack.

\* When using the optional thermal probe (part no. EAC110)

\*\* When the software which can be downloaded at our web page, is installed at PC using with separately purchased USB cable kit (part no. EAC400)

**● Exterior of the unit**

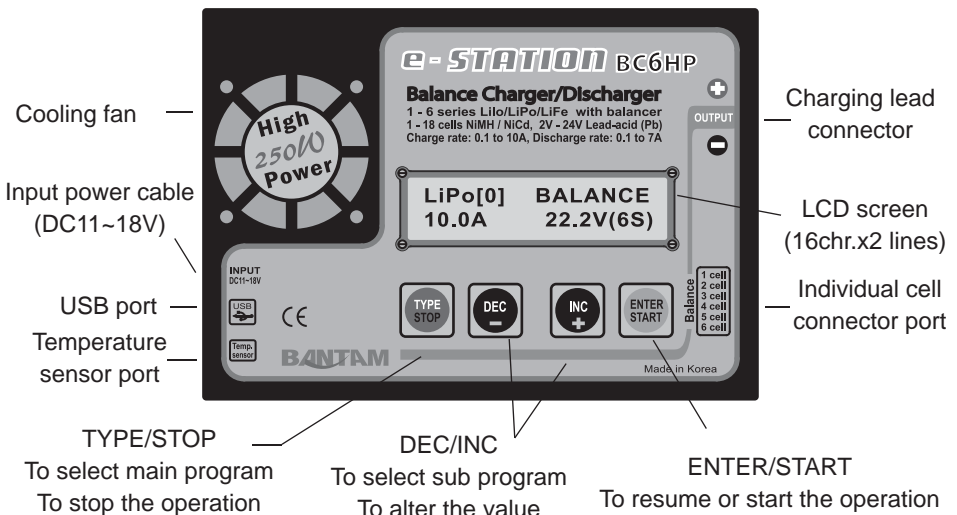

## ● Warnings and safety notes

- Never leave the charge unsupervised when it is connected to its power supply. If any malfunction is observed immediately terminate the process and refer to the operation manual.
  - Keep away the unit from dust, damp, rain, heat direct sunshine and vibration. Do not drop it.
  - The circuit of the unit is designed to be powered by 11 to 18V DC only.
- !** **This charger and the battery to charge or discharge should be set up on a head-resistant, non-inflammable and non-conductive surface. Never place them on a car seat, carpet or similar. Keep all the inflammable volatile materials well away from operating area.**
- Be careful to touch the charger body when charging or discharging at charger's maximum power. It may be very hot and can cause a physical damage on your finger or body.**
- Be sure to understand the information of the battery to be charged or discharged accurately. If the program is set up incorrectly the battery can severely be damaged. Especially Lithium battery can cause a fire or an explosion by over-charging.

**NiCd/NiMH voltage level: 1.2V/cell**

**allowable fast charge current: 1C ~ 2C**

**discharge voltage cut off level: 0.85V/cell(NiCd), 1.0V/cell(NiMH)**

**Lilo voltage level: 3.6V/cell**

**max. charge voltage: 4.1V/cell**

**allowable fast charge current: 1C or less**

**min. discharge voltage cut off level: 2.5V/cell or higher**

**LiPo voltage level: 3.7V/cell**

**max. charge voltage: 4.2V/cell**

**allowable fast charge current: 1C or less**

**discharge voltage cut off level: 3.0V/cell or higher**

**LiFe voltage level: 3.3V/cell**

**max. charge voltage: 3.6V/cell**

**allowable fast charge current: 4C or less (e.g. A123M1)**

**discharge voltage cut off level: 2.0V/cell or higher**

**Pb** voltage level: 2.0V/cell  
**(Lead-acid)** max. charge voltage: 2.46V/cell  
allowable fast charge current: 0.4C or less  
discharge voltage cut off level: 1.75V/cell or higher

- Do not attempt to charge or discharge the following types of battery.
    - Battery pack, which consists of different types of cell (including different manufacturers).
    - Battery, which is already fully charged or just slightly discharged.
    - Non-rechargeable batteries (Explosion hazard).
    - Batteries that require a different charge technique from NiCd, NiMH, Lilo, LiPo, LiFe or Pb.
    - Faulty or damaged battery.
    - Battery fitted with an integral charge circuit or a protection circuit.
    - Batteries installed in a device, or which are electrically linked to other components.
    - Batteries that are not expressly stated by the manufacturer to be suitable for the currents the charger delivers during the charge process.
- To avoid short-circuits between the charge lead, always connect the charge cable to the unit first and only then to the battery to be charged or discharged. Reverse the sequence when disconnecting.
- Do not connect more than one battery pack to the charge lead at any one time.
  - Please bear in mind of checking the following point before charge operation.
    - Did you select the appropriate program, which are suitable for the type of battery?
    - Did you set up adequate current for charging or discharging?
    - Lithium battery pack can be composed with parallel and series circuits mixed. You have to check the composition of the battery pack carefully before charging.
    - Are all connections firm and safe, or is there an intermittent contact at any point in the circuit?

**⚠ Those warnings and safety notes are particularly important. Please follow the instructions for a maximum safety; otherwise the charger and the battery can be damaged violently. And also it can cause a fire to injure a human body or to lose the property.**

# ● Program flow chart

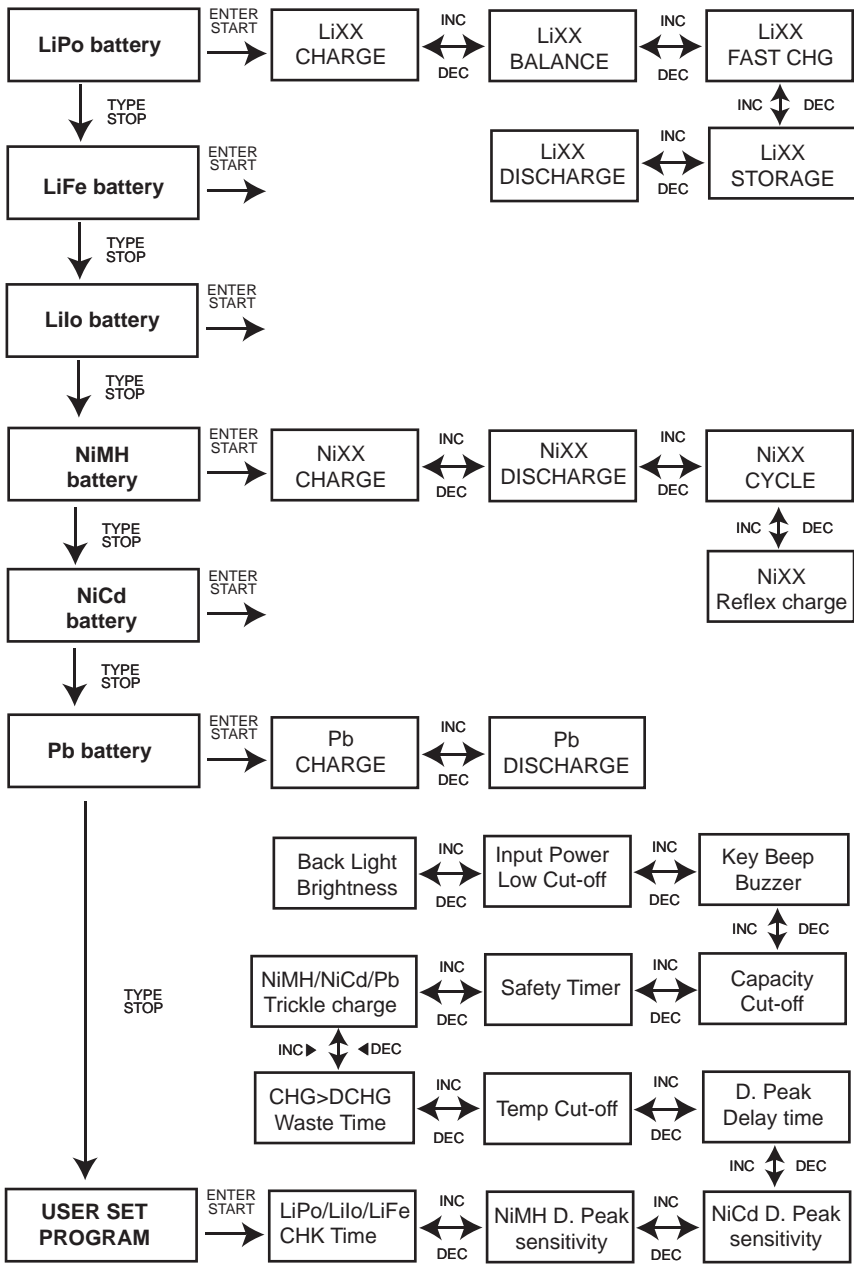

## ● Initial parameters setup (User Program Setup)

BC6HP will be operated with the default value of the essential user settings when it is connected to a 12V DC input power source for the first time. The screen displays the following information in sequence and the user can change the value of parameter on each screen.

When you are willing to alter the parameter value in the program, press 'ENTER/START' button to make it blinking, then change the value using 'INC' or 'DEC' button. The value will be stored by pressing 'ENTER/START' button once.

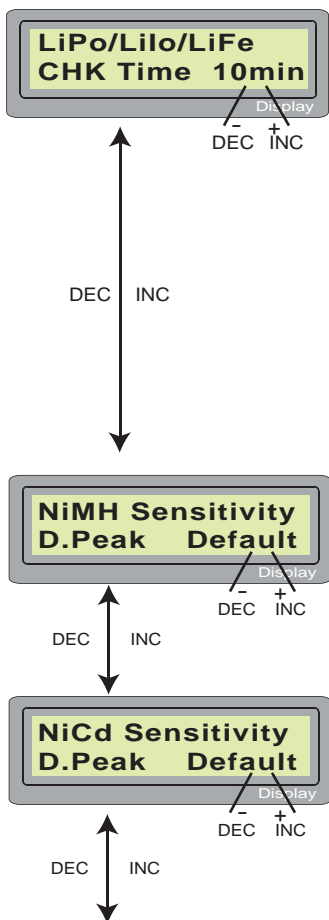

BC6HP recognises the cell count of Lithium battery automatically at the beginning of process to avoid from erroneous setting by user. But deeply discharged battery can be perceived incorrectly. To prevent the error, you can set the time term to verify the cell count by the processor. Normally, 10 minutes are enough to perceive the cell count correctly. For the battery of larger capacity, you may extend the time term. But if you set the time term too long for the battery of smaller capacity, the charge or discharge process can be finished within the time term with the erroneous cell count. This may cause the fatal result. If the processor recognizes the cell count incorrectly at the beginning of charge or discharge process, you may extend the time. Otherwise, you had better use with the default value.

This shows the trigger voltage for automatic charge termination of NiMH and NiCd battery. If the trigger voltage is set higher, there is a danger of overcharging the battery; if it is set lower, there is a possibility of premature termination. Please refer the technical specification of the battery.

(Disable, Delicate, Default, 5mV~20mV/cell)

**Disable;** The charger would not detect Delta-peak voltage for termination. To terminate charging process, the charger will check the parameters set up at other safety parameters like max. capacity, safety timer or safety temperature. If any one has been reached at its limit, the charging process will be terminated. (for NiMH only)

**Delicate;** The charger will detect a very small variation at delta-peak voltage. Some NiMH batteries which shows small voltage-drop at peak need to be use this option.

Default; If you do not know much about this function, or for ordinary batteries, select this mode. 12mV/cell for NiCd or 8mV/cell for NiMH will be used.

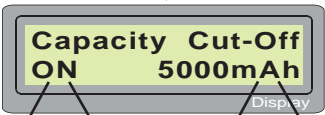
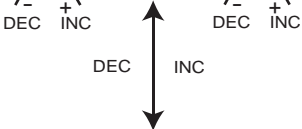
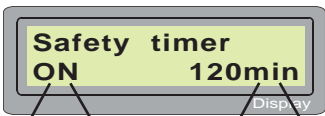
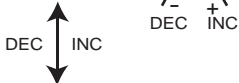
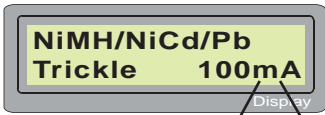
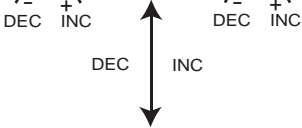
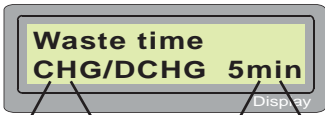
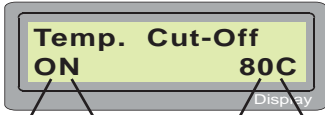
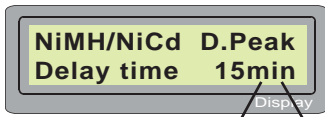

This restrains the delta-peak voltage detection until the time has reached. This prevents a premature cut-off from the battery of high internal resistance. The default value is one minute. (1 ~ 15 minutes)

An optional feature using temperature probe contacting the surface of battery, the temperature cut-off can be on or off. If it is on, set the maximum temperature at which the charger should allow battery to reach during charge. Once a battery reaches this temperature during operation, the process will be terminated to protect the battery.

The battery which is on the cyclic process of charge and discharge can often become warm after charge or discharge period. The program can insert a time delay to occur after each charge and discharge process to allow the battery adequate time to cool down before being subjected to the next process. The value ranges from 1 to 60 minutes.

You can set the trickle charge mode on or off. If it is on, the charger will automatically supply the trickle charge current to achieve the full charge without overheating the battery after fast charge has been terminated.

When you start a charge process, the integral safety timer automatically starts running at the same time. This is programmed to prevent overcharge the battery if it proves to be faulty, or if the termination circuit cannot detect the battery full. The value for the safety timer should be generous enough to allow a full charge of the battery.

This program sets the maximum charge capacity that will be supplied to the battery during charge. If the delta-peak voltage is not detected nor the safety timer expired by any reason, this feature will automatically stop the process at the selected capacity value.

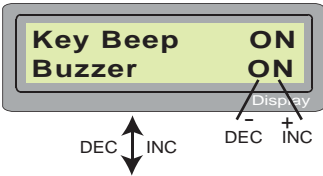

The beep sounds at every time pressing the buttons to confirm your action. The beep or melody sounded at various times during operation to alert different mode changes. These audible sounds can be on or off.

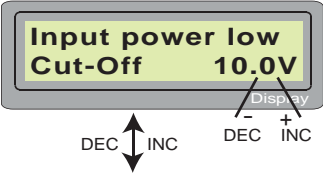

This program monitors the voltage of input battery. If the voltage drops below the value you set the operation forcibly terminated to protect the input battery.

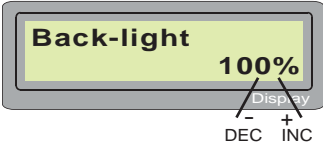

You can adjust the brightness of LCD screen at the charger.

## ● Program Memory

BC6HP can store the setting data of every program for your convenience. This feature can store up to 10 battery data for each type of batteries by number that represents the individual parameters.

They can be called back for the process of charging or discharging without setting up the program again.

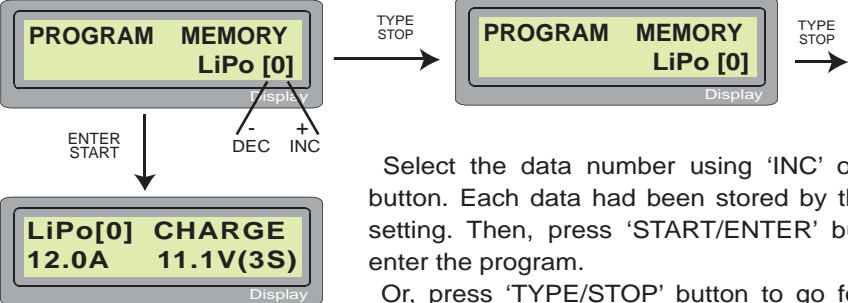

Select the data number using 'INC' or 'DEC' button. Each data had been stored by their last setting. Then, press 'START/ENTER' button to enter the program.

Or, press 'TYPE/STOP' button to go for other program.

**⚠ Battery connection to charger**

All batteries are charged should be connected through the main charge leads go to output port of charger. The balance connection which goes to balance port is only required when running 'Balance' program.



## Charging Lithium battery at balance mode

This is for balancing the voltages of Lithium batteries of the battery pack to be charged. To do this, the battery pack being charged should have the individual cell connector, and connect it to the individual port at the right side of charger with a suitable connection cable that fits with your battery pack. **And you should connect the battery output plug to the output of charger either.**

In this mode, the charger will monitor the voltages of each cell of the battery pack and controls the charging current that is feeding to each cell to equalize the voltage.

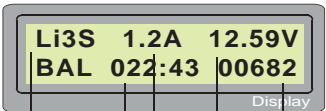
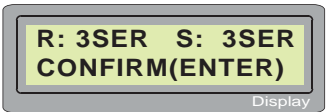
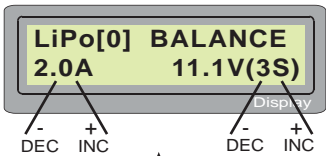

number of cells    charging time    charge current    battery voltage    charged capacity

The value on the left side of second line sets a charge current and the value on the right side of second line sets the voltage of the battery pack.

After setting the current and voltage press 'ENTER/START' button for more than 3 seconds to start the process.

(Charge current: 0.1~10.0A, Voltage: 2~6 series)

This shows the number of cells you set up and the processor detects. 'R:' shows the number of cells found by the charger and 'S:' is the number of cells selected by you at the previous screen. If both numbers are identical you can start charging by press 'ENTER/START' button. If not, press 'TYPE/STOP' button to go back to previous screen. Then carefully check the number of cells of the battery pack again.

The screen shows the present situation during charge process. To stop charging press 'TYPE/STOP' button once.

## Individual cell connection diagram

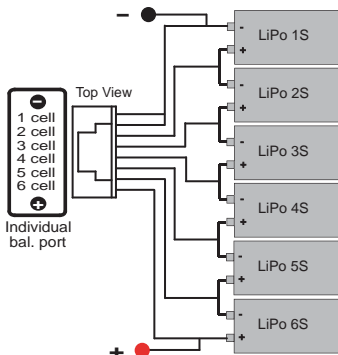

### \* 8-pin plug assignment

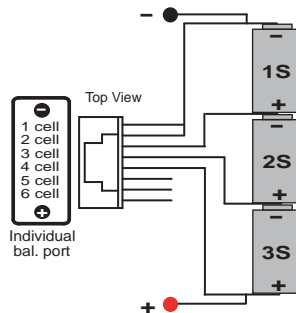

## 'FAST' charging Lithium battery

The charging current is getting smaller as the process goes to the near end term of Lithium battery charging. To finish charging process earlier, this program eliminate certain term of CV process. Actually, the charging current will goes to 1/5 from the initial value to end the process while the normal charging goes to 1/10 at end of CV term. The charging capacity may be a bit smaller than normal charging but the process time will be reduced.

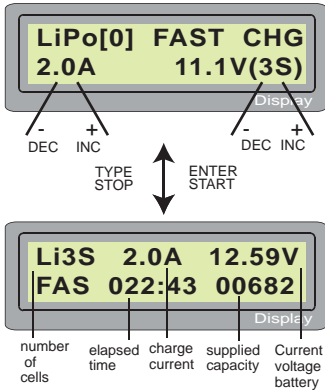

You can set up the charging current and the voltage of the battery pack being charged. As you press 'ENTER/START' button the voltage confirmation will be displayed. And then, if you confirm the voltage and current, press 'ENTER/START' button again to start charging.

This shows the present state of 'FAST' charging. To stop charging arbitrary, press 'TYPE/STOP' button once.

## 'STORAGE' control Lithium battery

This is for charging or discharging Lithium battery not to be used for the time being. The program will determine to charge or discharge the battery to the certain voltage depending on the voltage of the battery at its initial stage. They are different from the type of the battery, 3.7V for Lilo, 3.8V for LiPo and 3.3V for LiFe per cell. If the voltage of battery at its initial stage is over the voltage level to storage, the program will start to discharge first.

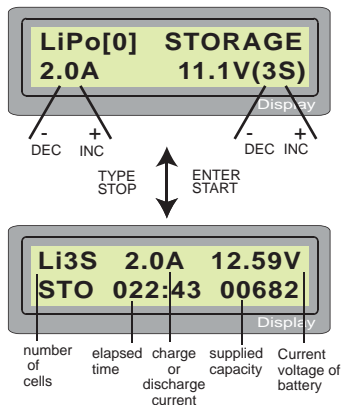

You can set up the current and the voltage of the battery pack to be charged. The current will be used for charge or discharge the battery to reach the 'storage' level of voltage.

## Discharging Lithium battery

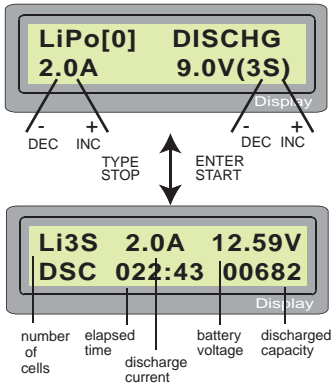

The value of discharge current on the left side of screen may not exceed 1C for a maximum safety. The final voltage at the end of discharge is on the right according to the cell count and type of battery. For LiPo, it is 3.0V/cell.

To start to discharge press 'ENTER/START' button for more than 3 seconds.  
(Discharge current: 0.1~7.0A)

### \* Discharge current limit by circuit power

For the voltage of battery is more than 3.6V, the actual amount of discharge current may be limited automatically, not to exceed the charger's maximum rated discharging power of 25 watts.

### \* Voltage monitoring during the discharge

The charger monitors the voltage of individual cells during discharge mode of Lithium battery pack. For this feature, the individual plug of the battery pack should be connected to the individual port of the charger. If the voltage of any one or more cells varies abnormally during discharge, BC6HP terminates the process forcibly with the error message. If this happens, the battery pack contains a bad cell, or bad connection of the cable or plug. You can easily know which one cell is not normal by pressing 'INC' button at time of showing the error message.

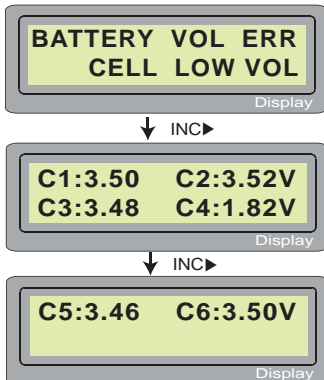

The processor found that the voltage of one of the cell in the Lithium battery pack is too low.

In this case, the 4th cell is bad. If there happens the connection-break of the cable or plug, the voltage value may show zero.

## ● NiMH/NiCd battery program

These programs are for charging or discharging NiMH (Nickel-Metal-Hydride) or NiCd (Nickel-Cadmium) battery commonly used for R/C model applications.

### Charging NiCd/NiMH battery

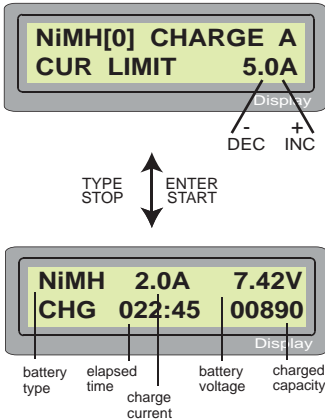

This program simply charges the battery using the current you set. You can select charge current mode in 'A'(automatic) or 'M'(manual). In 'Auto' mode, you need to set the upper limit of charge current to avoid from higher feeding current that may damage the battery. Because some batteries of low impedance and small capacity can lead to the higher charge current by the processor at automatic charge mode. But in 'Man' mode, it will charge the battery with the charge current you set at the display.

- Press 'ENTER/START' button to make 'M' or 'A' blinking.
- Change the current mode to 'M' or 'A' using 'INC' or 'DEC' button.
- Press 'ENTER/START' button to alter the charge current.
- Change the current value using 'INC' or 'DEC' button.
- Press 'ENTER/START' button for more than 3 seconds to start charging.

### Discharging NiCd/NiMH battery

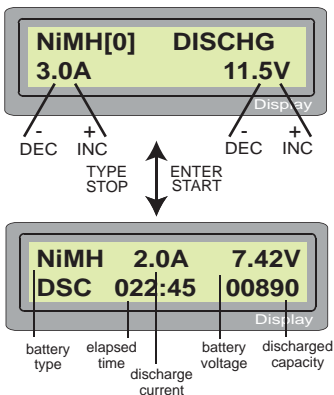

Set discharge current on the left and final voltage on the right. The discharge current ranges from 0.1 to 7.0A and the final voltage ranges from 0.1 to 25.0V).

To protect the battery from damage by deep discharge, set the final cut-off voltage at safe range. The minimum cut-off voltage is 0.85V/cell for NiCd and 1.0V/cell for NiMH. If you set the voltage as 'AUTO', the charger will determine the final voltage depending on the battery condition.

## Cycle (C>D, D>C) mode NiMH/NiCd battery

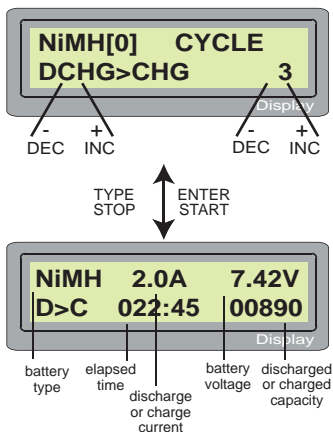

Set the sequence on the left and the number of cycle on the right. You can use this function for balancing, refreshing and break-in the battery. To avoid rising temperature of the battery, there will a brief cool-off period that already fixed at 'User program setup' after each charge and discharge process.

The cycle program uses the charge current, discharge current and discharge cut-off voltage which are set on previous programs-'charge' and 'discharge'.

The cycling number ranges from 1 to 5.

At the end of the process, you can see charged or discharged electric capacities of the battery at each cyclic process.

By pressing 'INC' or 'DEC' button, the screen shows the charged or discharged capacity of each cycle in order.

## Reflex charge NiMH/NiCd battery

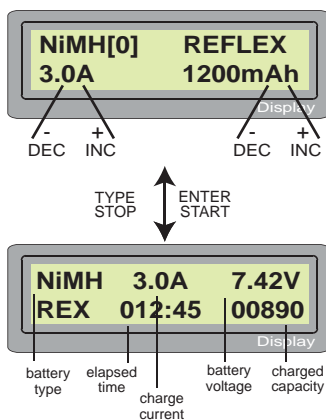

The battery will be charged using the pulsed current which is very brief and high-rate discharge pulses. This will help to prevent from undesired side effect like 'memory effect'. When you select this mode, you need to set the partial capacity which will be charged with reflex mode. The charger will work with 'Reflex' mode only until the capacity has been charged, then the charger will work at 'Normal mode'.

- Set the charge current on the left and the partial capacity on the right. The partial capacity should be less than the total capacity of battery.

- Press and hold 'ENTER/START' button for more than 3 seconds to start the process.

# ● Pb (lead-sulphuric acid) battery program

This is programmed for charging and discharging Pb (lead-acid) battery of nominal voltage from 2 to 24V. Pb batteries are totally different from NiCd or NiMH batteries. They can only deliver relatively lower current compare to their capacity, and similar restrictions definitely apply to charge. So the optimal charge current will be 1/10 of the capacity. Pb batteries must not be charged rapidly. Always follow the instruction which is supplied by the manufacturer of battery.

## Charging Pb battery

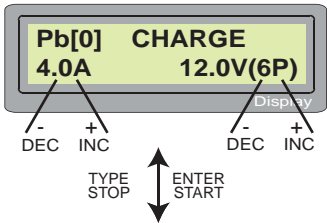

Set up the charge current on the left and the nominal voltage of the battery on the right. The charge current ranges from 0.1 to 10.0A and the voltage should be matched with the battery being charged.

ENTER the charge process by pressing 'ENTER/START' button for more than 3 seconds.

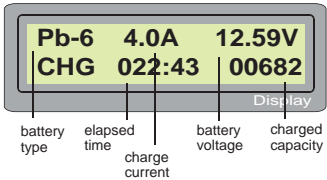

The screen displays the state of charging process. To stop charging forcibly, press 'TYPE/STOP' button once.

## Discharging Pb battery

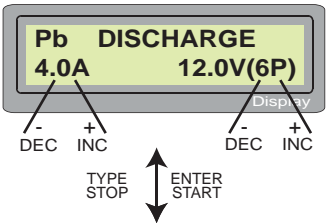

Set discharge current on the left and final voltage on the right. The discharge current ranges from 0.1 to 7.0A.

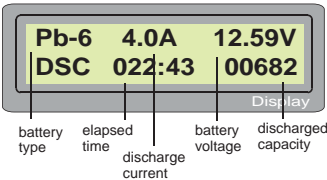

The screen displays the current state of discharge. To stop discharging press 'TYPE/STOP' button once. The audible sound indicates you at the end of process.

## ● Various information during the process

You can inquire various information on LCD screen during charging or discharging process. When you press 'DEC' button the charger shows the establishment of user settings. And also you can monitor the voltage of individual cell by pressing 'INC' button when the individual connection cable is linked to the Lithium battery being processed.

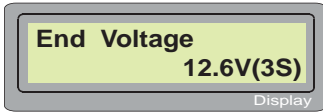

The final voltage will be reached at the end of process.

DEC ↓

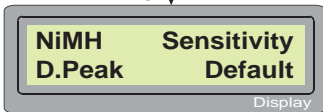

DEC ↓

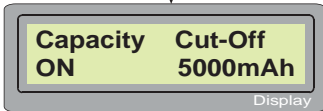

DEC ↓

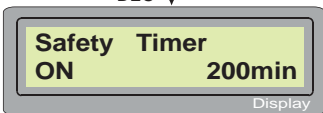

DEC ↓

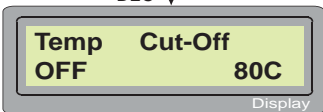

DEC ↓

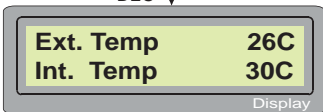

The internal temperature of the charger and the temperature of battery being charged.  
(The external temperature only will be displayed when using the thermal probe.)

DEC ↓

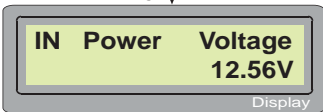

The present voltage of input DC power.

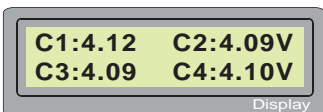

↓ INC

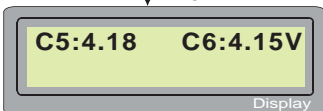

Using the individual connection cable to the battery, you can check the individual voltages of each cell in the battery pack. When connect the cable to the port on the right side of the charger the program shows them for maximum 6 cells in sequence. To utilise this feature, the battery pack must have output connector that linked to each cells.

## ● Warning and error messages

BC6HP incorporates a various functions of protective and monitoring the system to verify functions and the state of its electronics. In any case of occurring error, the screen displays the cause of error that is self-explanatory with audible sound.

**REVERSE POLARITY**

Display

The output is connected to a battery with incorrect polarity.

**CONNECTION BREAK**

Display

This will be displayed in case of detecting an interruption of the connection between battery and output or voluntarily disconnecting the charge lead during the operation of charge or discharge on output.

**SHORT ERR**

Display

There was a short-circuit at OUTPUT. Please check the charging leads.

**INPUT VOL ERR**

Display

The voltage of input power drops below the limit.

**VOL SELECT ERR**

Display

The voltage of Lithium battery pack was selected incorrectly. Verify the voltage of battery pack carefully.

**BREAK DOWN**

Display

There happens the malfunction at the charger circuit by any reason. The charger should be repaired at our factory.

**BATTERY CHECK  
LOW VOLTAGE**

Display

The processor detects the voltage is lower than you set at Lithium program. Please check the cell count of the battery.

**BATTERY CHECK  
HIGH VOLTAGE**

Display

The processor detects the voltage is higher than you set at Lithium program. Please check the cell count of the battery.

**BATTERY VOLTAGE  
CELL LOW VOL**

Display

The voltage of one of the cell in the Lithium battery pack is too low. Please check the voltage of the cell one by one.

**BATTERY VOLTAGE  
CELL HIGH VOL**

Display

The voltage of one of the cell in the Lithium battery pack is too high. Please check the voltage of the cell one by one.

**BATTERY VOL ERR  
CELL CONNECT**

Display

There are bad connection at the individual connector. Please check the connector and cables carefully.

**TEMP OVER ERR**

Display

The internal temperature of the unit goes too high. Cool down the unit.

**CONTROL FAILURE**

Display

The processor can not continue to control the feeding current by any reason. The unit needs to be repaired.

## ● Glossary of terms

**Amps(A):** The unit of measure for charge or discharge electric current. The program of the charger will show most of the current in amps(A) at its LCD screen.

**Milli-amps(mA):** The electric current, being amps(A) multiplied by 1000 and noted as 'mA'. So 2.0A is the same as 2000mA (2.0x1000). Or, to convert mA to amps, divide the mA number by 1000. So 200mA is the same as 0.2A. If a current value is below 1.0A, the LCD screen of the charger will still show the current in amps, not milli-amps. For example, a current of 600mA will be displayed as 0.6A, and a current of 100mA will actually be shown as 0.1A.

**Capacity, milli-amp hours (mAh), and amp-hours (Ah):** Charge energy stored by a battery is called capacity, which is defined as how much current a battery can supply constantly over one hour of time. Most hobby batteries are rated for capacity in 'mAh' or milliamp hours. A 650mAh battery can deliver 650mA of current for one hour (650mA x 1hr = 650mAh). The batteries of very large capacity, such as lead-acid(Pb) batteries, are usually rated in 'Ah' or amp-hours. A '12V 60Ah' car battery can deliver 60 amps of current for one hour (60A x 1hr = 60Ah).

**Nominal voltage(V):** The nominal voltage of the battery pack can be determined as follows;

-NiCd or NiMH: multiply the total number of cells in the pack by 1.2. A 8-cell pack will have a nominal voltage of 9.6 volts (8x1.2).

-.LiPo: multiply the total number of cells in the pack by 3.7. A 3-cell LiPo wired in series will have a nominal voltage of 11.1 volts (3x3.7).

-.Lilo: multiply the total number of cells in the pack by 3.6. A 2-cell Lilo wired in series will have a nominal voltage of 7.2 volts (2x3.6).

-.LiFe: multiply the total number of cells in the pack by 3.3. A 4-cell Lilo wired in series will have a nominal voltage of 13.2 volts (4x3.3).

If the nominal voltage of the battery is not printed on the battery's label, consult your battery manufacturer or supplier. Do not guess the rated voltage of battery.

**'C'-rating:** Capacity is also referred to as the 'C' rating. Some battery suppliers recommend charge and discharge currents based on the battery 'C' rating. A battery's '1C' current is the same number as the battery's rated capacity number, but noted in mA or amps. A 600mAh battery has a 1C current value of 600mA, and a 3C current value of (3 x 600mA) 1800mA or 1.8A. The 1C current value for a 3200mAh battery would be 3200mA (3.2A).

## ● Balancing the multi Lithium battery packs

You can charge and balance several Lithium batteries at the same time, by using optional 'Multi-board adaptor'(\*). Please note that the battery packs being charged should have same capacity and cell-count.

\* Part no. EAC143, EAC144, EAC148 and EAC149. Please read the instructions come with the board for the maximum safety.

### ex) 2 x 3S connection using serial charging

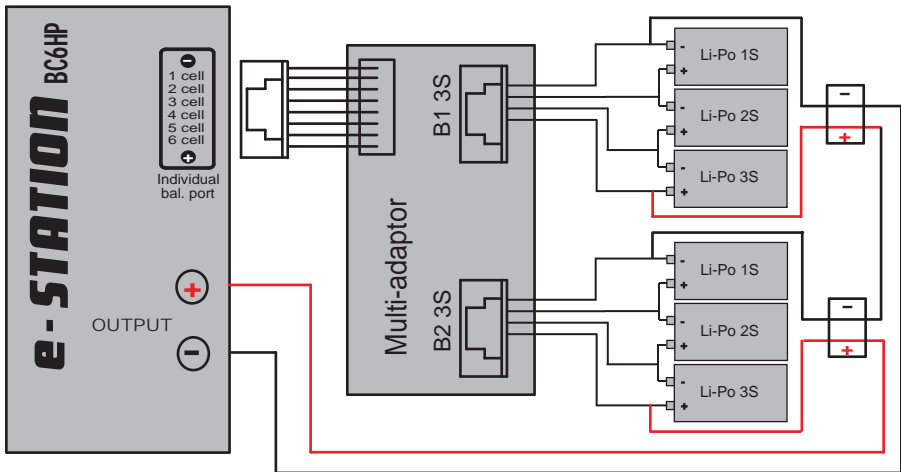

### ex) 3 x 2S connection using serial charging

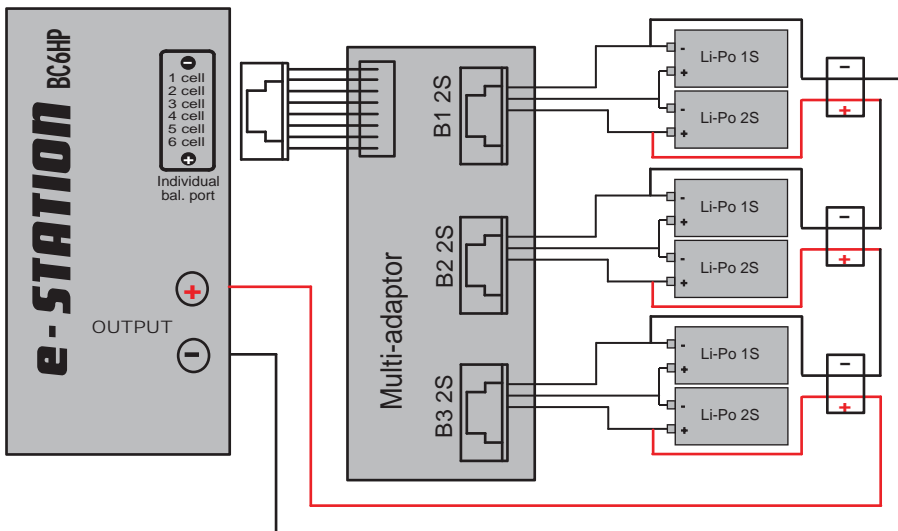

## ● Specifications

Operating voltage range :	11.0 ~ 18.0 Volt
Circuit power:	max. 250Watts (Charging) max. 25 Watts (discharging)
Charge current range :	0.1 ~ 10.0A
Discharge current range :	0.1 ~ 7.0A
Current drain for balancing Lipo:	200mAh/cell
NiCd/NiMH battery cell count :	1 ~ 18 cells
Lithium battery cell count :	1 ~ 6 Series
Pb battery voltage :	2 to 24V
Weight :	580 g
Dimensions :	140 X 120 X 40 mm

## ● Warranty and service

We warrant this product for a period of one year (**12 months**) from the date of purchase. The guarantee applies only to such material or operational defects, which are present at the time of purchasing the product. During that period, we will repair or replace without service charge any product deemed defective due to those causes. You will be required to present proof of purchase (invoice or receipt). This warranty does not cover the damage due to wear, overloading, incompetent handling or using of incorrect accessories.

### **BANTAM Inc.**

#623 Unitech Ville 1141-2  
BAEKSEOKDONG ILSANDONGGU  
GOYANGSI KYUNGGIDO  
KOREA 410-722  
Phone: +82 31 904 3939, Fax: +82 31 901 6439  
E-mail: [bantamtek@bantamtek.com](mailto:bantamtek@bantamtek.com)  
Web: [www.bantamtek.com](http://www.bantamtek.com)

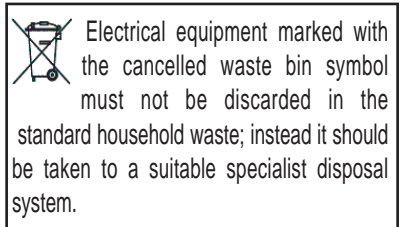

Date of purchase/delivery :

Dealer :